

Speed Transducer FGA 20 - RSLE

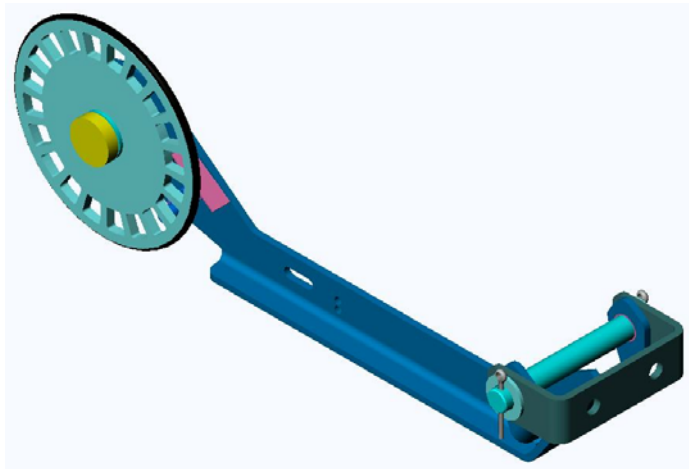

- **cost-efficient integration**
- **high reliability**
- **maintenance-free bearings and sealings**
- **easy handling**
- **completely made of galvanized steel or stainless steel**
- **legal-for-trade variant for Belt Weighers Type MULTIBELT®**
- **suitable for use in ATEX explosion-prone zones**

Application

Speed Transducers type FGA 20 are intended for the monitoring of the belt speed of conveyor belt systems.

They are used as an optional device for Belt Weighers type MULTIBELT®. The speed transducer of ATEX design is suitable for use in explosion-prone zones: 2; 1 and 22; 21.

Design

The Speed Transducer consists of a rocker swivel-mounted around an axle. The axle is held in a bracket which is attached to the equipment to be monitored (conveyor belt system).

Fastened to this rocker is the measuring wheel which runs without slippage on the belt to be measured. The belt speed is monitored by means of windows in the measuring wheel and with one or two (legal-for-trade) proximity switch(es) as frequency signal and processed with an evaluation device.

The Speed Transducer FGA 20 is completely made of galvanized steel or of stainless steel AISI 304 in a particularly corrosion-resistant version as well as in the ATEX-approved design.

Performance

The pulse wheel runs with a rubber ring on the inside of the empty return belt of a conveyor belt system. The wheel rests frictionally engaged with its own weight on the belt and is set in rotation by the belt movement. Due to the non-slip drive the circumferential speed of the wheel corresponds to that of the belt.

The speed of the wheel is monitored with a sensor which is energized intermittently by an alternating arrangement of windows and webs, and thus excites a frequency which corresponds to the belt speed of the conveyor belt system. This frequency is transmitted to the evaluation electronics for further processing.

Dimensions / (mm):

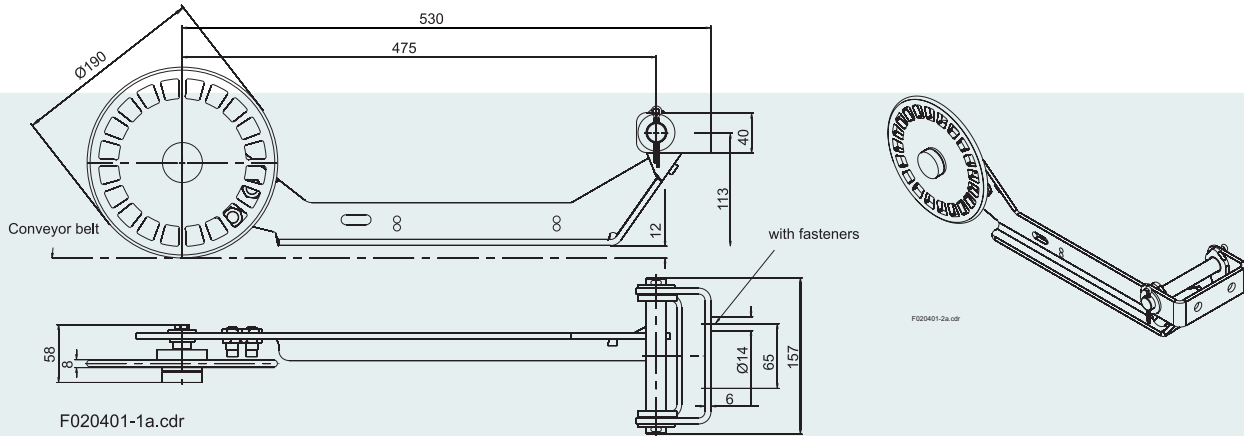

Working temperature:	- 20° to + 50° Celsius
Belt speeds:	up to 3.5 m/s
Specific values:	20 pulses per revolution = 33.5 pulses per meter of belt
Output signal:	Namur
Weight:	4.55 kg

Installation of the FGA20 - RSLE

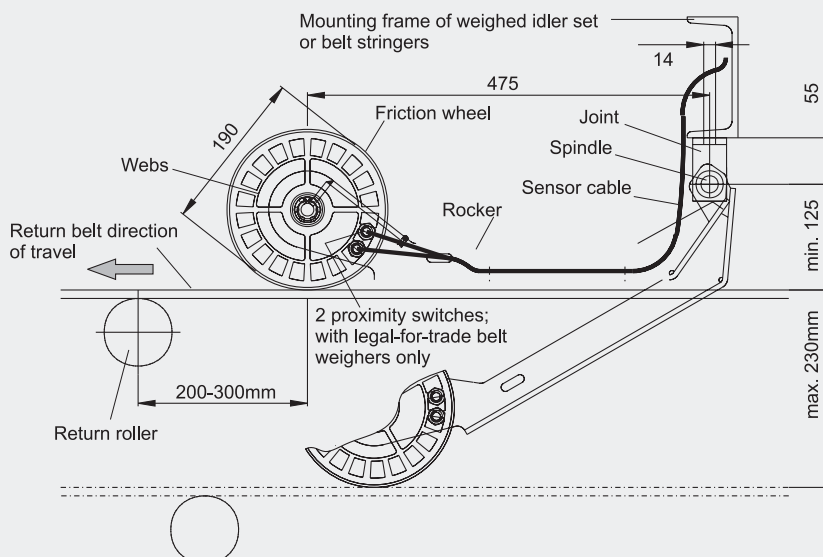

Schenck Process GmbH
Pallaswiesenstr. 100
64293 Darmstadt, Germany
T +49 6151 32-1216
F +49 6151 32-1172
components@schenckprocess.com
www.schenckprocess.com